

Admission Exam PPG-EM – 2022/2^o sem

Candidate Name:
ID:
Date:
Signature:

Instructions

- 1) The exam consists of 10 questions, and the candidate must choose 5 questions to solve. In case the candidate solves a greater number of questions, only the first 5 will be considered;
- 2) All questions have the same value (2.0 points for each question);
- 3) The resolution of the questions must be in the space reserved for them, and the back of the page may be used;
- 4) The final answer to the questions must be placed in the box intended for them (below the statement);
- 5) For the question to be considered correct, its resolution (or justification) must be in the corresponding space (checkered area);
- 6) It is not allowed to consult any type of material;
- 7) The use of simple (non-programmable) electronic calculators is permitted;
- 8) All sheets must be identified with full name;
- 9) The duration of the exam is 2 hours.

For the exclusive use of examiners

QUESTIONS SCORES									
Q1		Q3		Q5		Q7		Q9	
Q2		Q4		Q6		Q8		Q10	

TOTAL SCORE

São Carlos School of Engineering - University of São Paulo
Admission Exam PPG-EM – 2022/2º sem

Name: _____ Signature: _____

QUESTION 1: (Linear Algebra)

Determine the vector d , solution of $Bd = c$, knowing that $B = A^T A$ and $c = v \times w$.

The matrix A and the vectors v and w are defined below.

$$A = \begin{bmatrix} 2 & -1 & 0 \\ -1 & 2 & 1 \\ 0 & -1 & 2 \end{bmatrix}, \quad v = \begin{pmatrix} -1 \\ 0 \\ 1 \end{pmatrix} \quad \text{and} \quad w = \frac{1}{2} \begin{pmatrix} 5 \\ -6 \\ 5 \end{pmatrix}$$

Justify your answer in the checkered area.

Answer:



São Carlos School of Engineering - University of São Paulo
Admission Exam PPG-EM - 2022/2º sem

Name: _____ Signature: _____

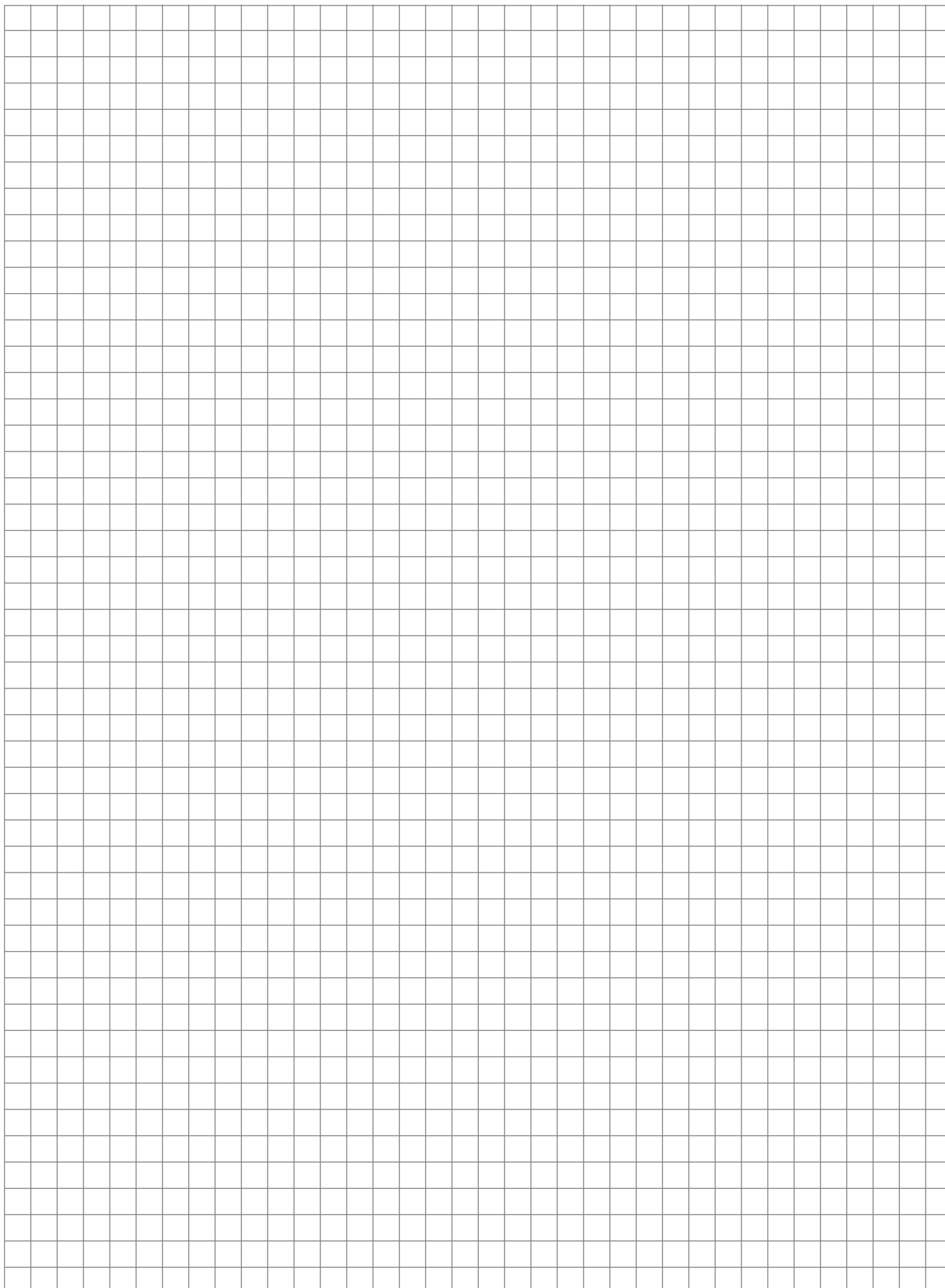

São Carlos School of Engineering - University of São Paulo
Admission Exam PPG-EM - 2022/2º sem

Name: _____ Signature: _____

QUESTION 2: (Differential and Integral Calculus)

Find the volume obtained by rotation around the y-axis of the region delimited by $y = x^3$, $y = 8$ and $x = 0$, and represent the figure in a XYZ graph.

Justify your answer in the checkered area.

Answer:

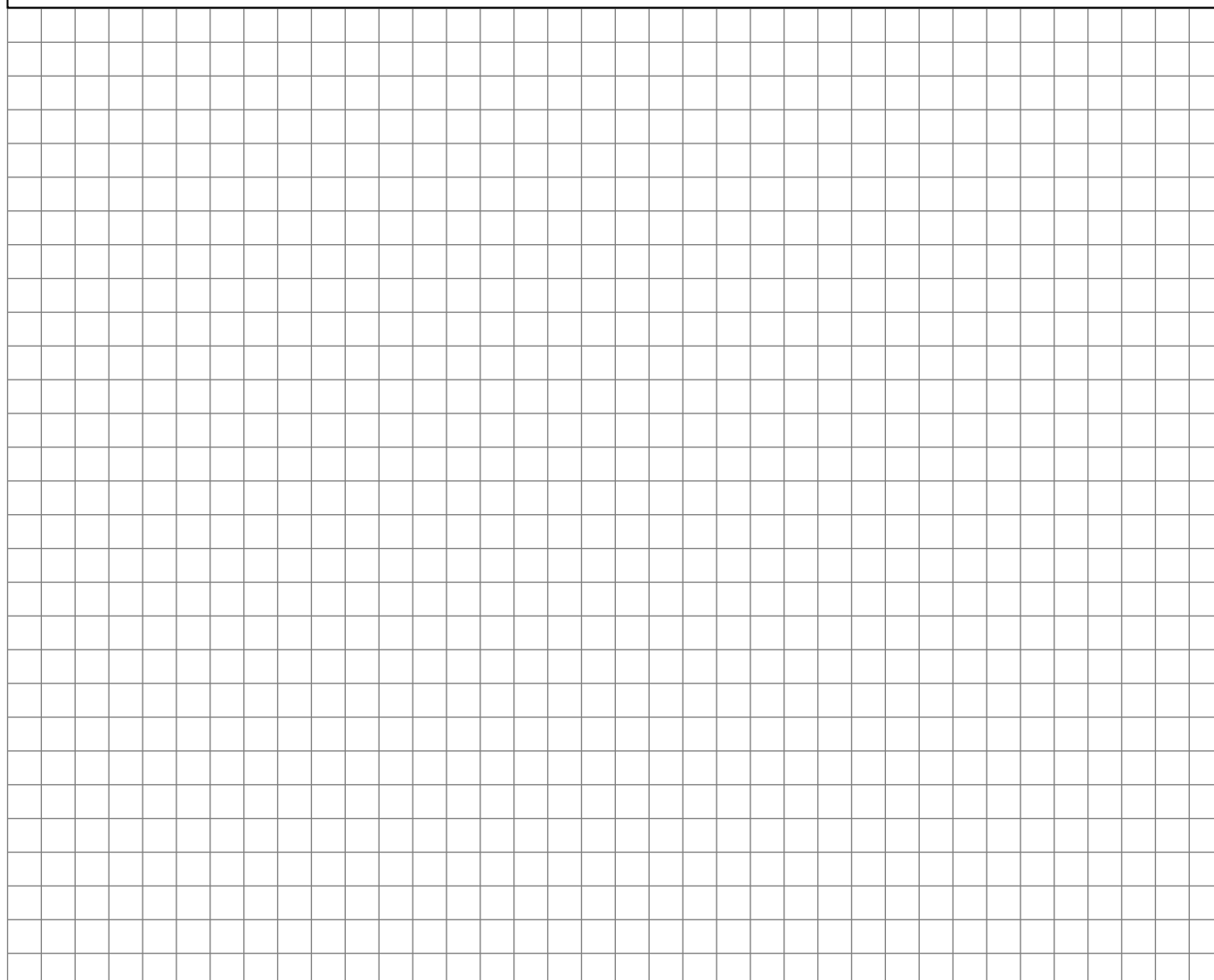

São Carlos School of Engineering - University of São Paulo

Admission Exam PPG-EM - 2022/2º sem

Name: _____ Signature: _____

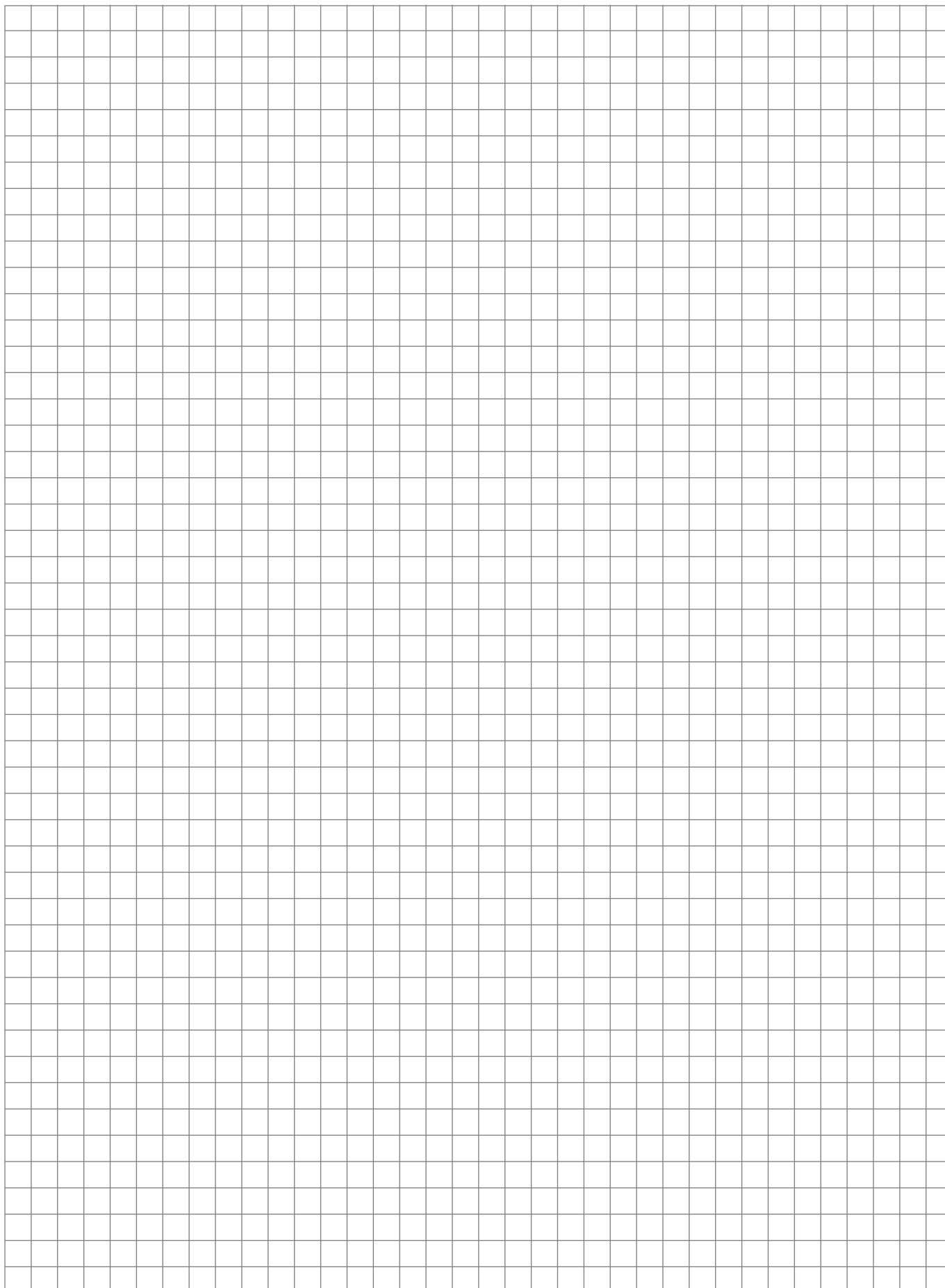

São Carlos School of Engineering - University of São Paulo
Admission Exam PPG-EM - 2022/2º sem

Name: _____ Signature: _____

QUESTION 3: (Computation)

Analyze the code below:

```
1  #include <stdio.h>
2  #include <math.h>
3
4  int function(int value1, int value2)
5  {
6      if(value1 == 0)
7      {
8          printf("0");
9      }
10     else if(value1/(int)pow(2, value2))
11     {
12         int res = function(value1, value2+1);
13         if(res/(int)pow(2, value2))
14         {
15             printf("1");
16             return res - (int)pow(2, value2);
17         }
18         else
19         {
20             printf("0");
21             return res;
22         }
23     }
24     else
25     {
26         return value1;
27     }
28 }
```

```
29
30 int main(int argc, char *argv[])
31 {
32     if(argc != 2)
33     {
34         printf("Entrada dada no formato executavel numero");
35         return 1;
36     }
37     function(atoi(argv[1]), 0);
38 }
```

Assuming that the code below was compiled to create an executable file called test, (a) describe what happens if we run the test executable followed by the value 56, for example:

C:\User\Pos\Prova> ./test 56

(b) What is the type of computational resource used in a function to generate a result called?

Name: _____ Signature: _____

QUESTION 4: (Electronics)

In the circuit below, a potentiometer P was placed to adjust the gain of the amplification stage between a signal source (V_{in}) and the output of the circuit (V_{out}). Consider that P is a composition of two resistors (R_1 and R_2). Assume that the potentiometer P is set exactly in the middle ($R_1 = R_2 = 1\text{ k}\Omega$) and that the op amp (U1) is an ideal component. Determine the value of the input resistance and the gain of the amplification stage (V_{out}/V_{in}).

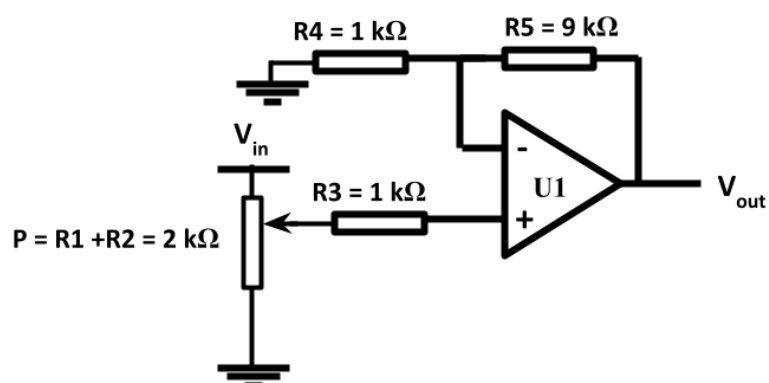

Justify your answer in the checkered area.

Answer:

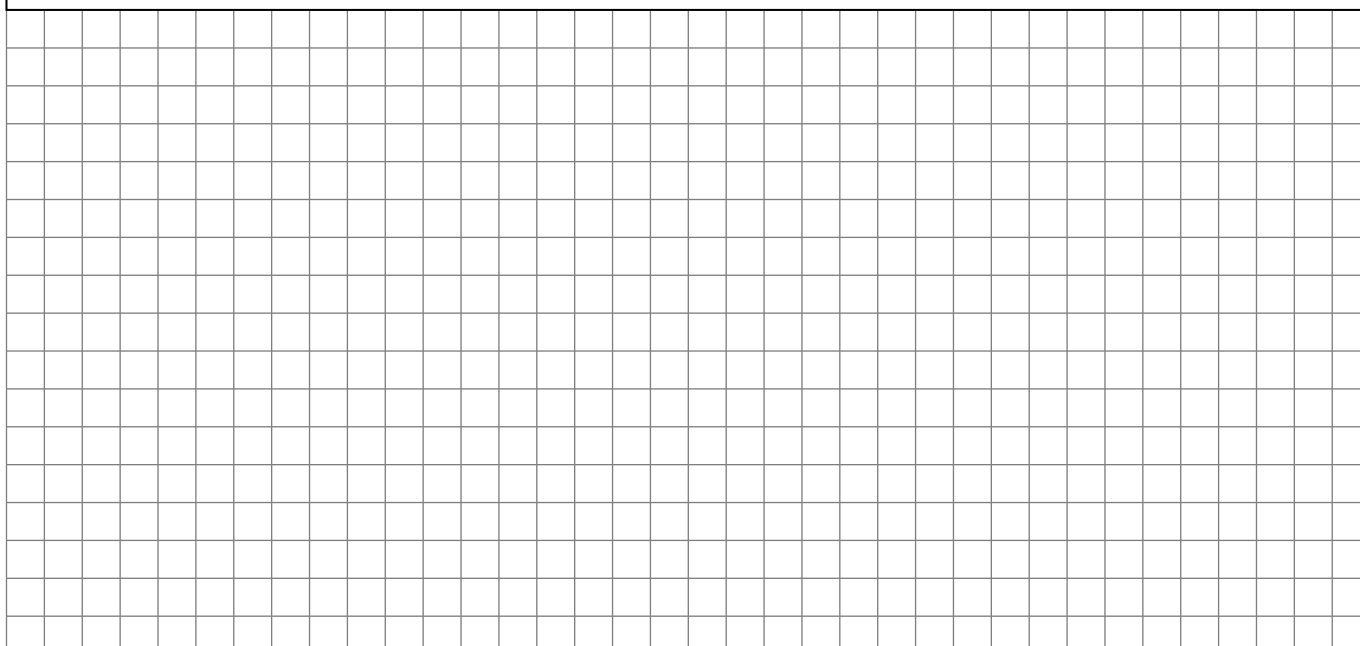

São Carlos School of Engineering - University of São Paulo
Admission Exam PPG-EM – 2022/2º sem

Name: _____ Signature: _____

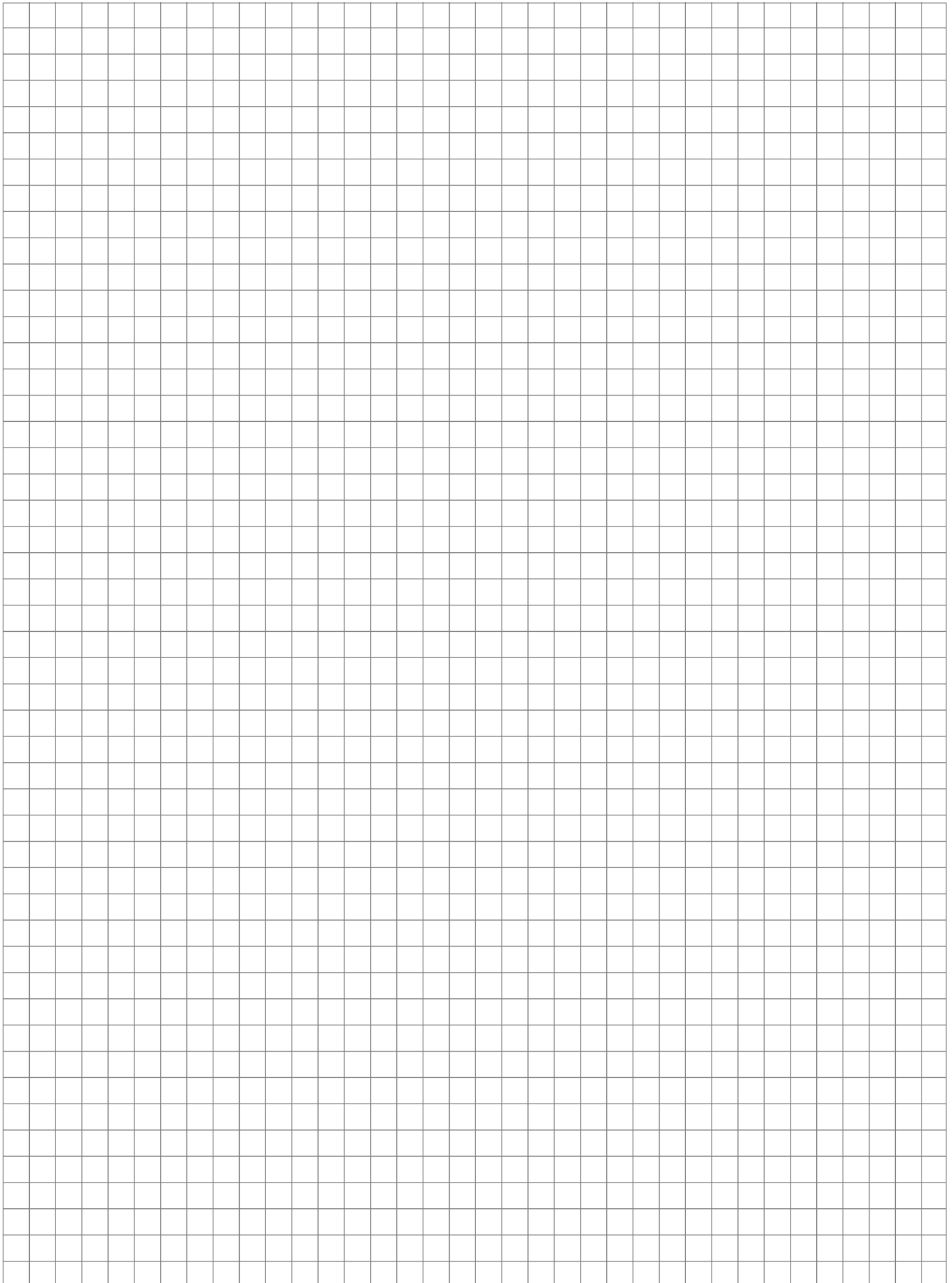

Name: _____ Signature: _____

QUESTION 5: (Control Systems)

A second-order system has the characteristic equation described as:

$$s^2 + 2\zeta\omega_n s + \omega_n^2 = 0,$$

where ζ is the damping factor and ω_n is the natural frequency. For a second-order system, the overshoot for a step input can be calculated as:

$$\text{Sobresinal}_{\%} = 100 e^{-(\zeta\pi/\sqrt{1-\zeta^2})}$$

Determine the value of K so that the response to a step input of the closed-loop system illustrated in the figure has no overshoot and the fastest rise time.

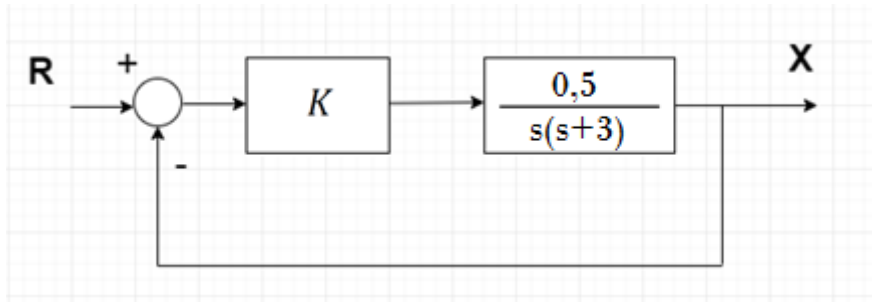

Justify your answer in the checkered area.

Answer:

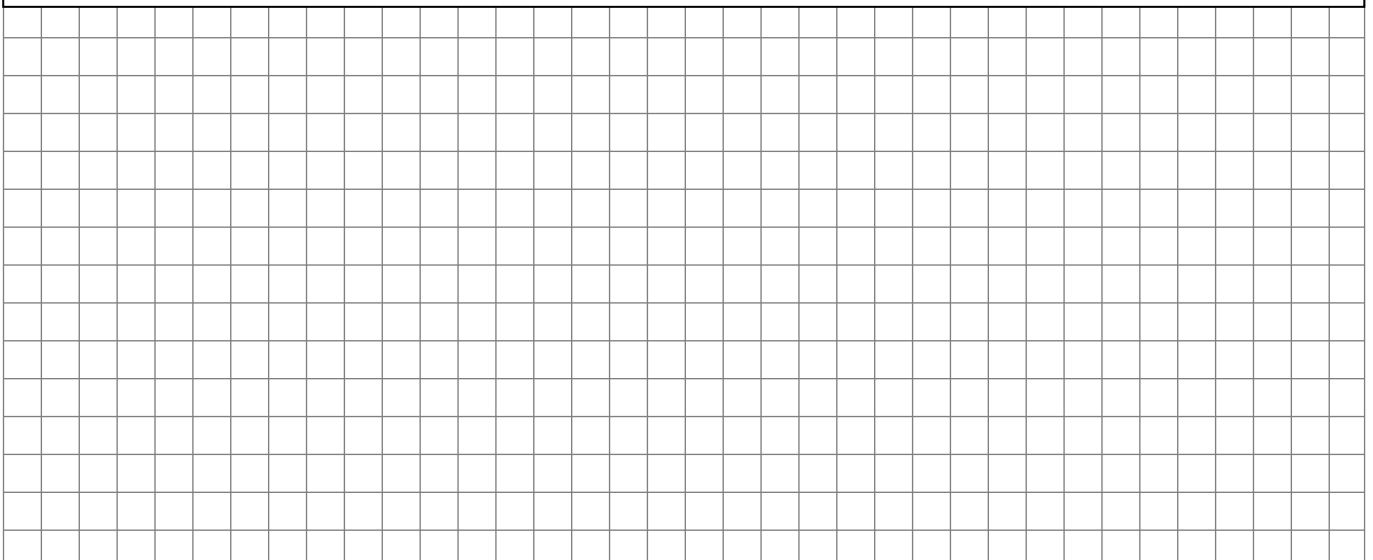

São Carlos School of Engineering - University of São Paulo
Admission Exam PPG-EM - 2022/2º sem

Name: _____ Signature: _____

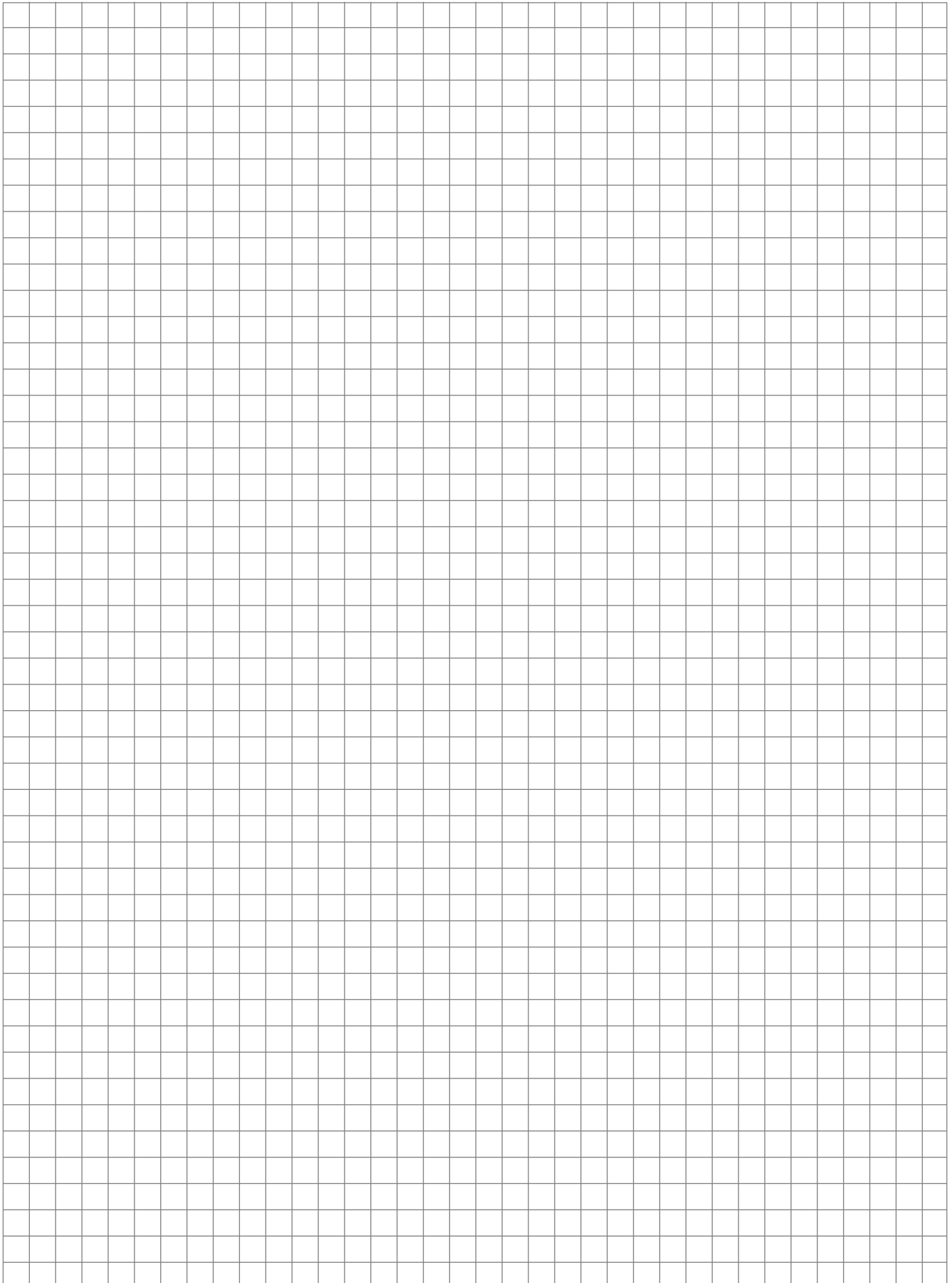

São Carlos School of Engineering - University of São Paulo
Admission Exam PPG-EM - 2022/2º sem

Name: _____ Signature: _____

QUESTION 6: (Materials)

Sketch schematically the microstructure of (a) a hypereutectoid carbon steel and (b) a white eutectic cast iron, indicating the phases and constituents.

Justify your answer in the checkered area.

Answer:

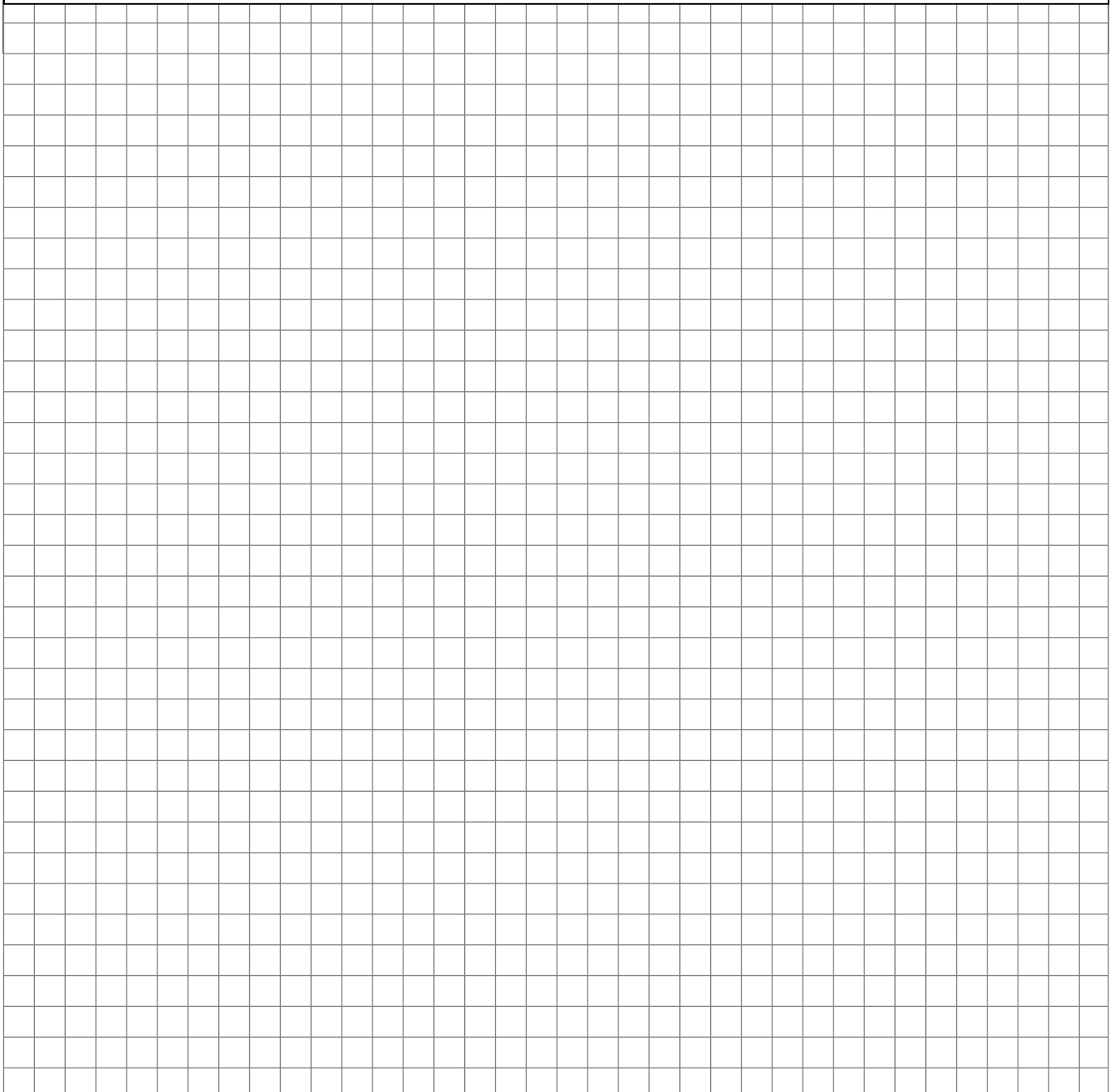

São Carlos School of Engineering - University of São Paulo
Admission Exam PPG-EM - 2022/2º sem

Name: _____ Signature: _____

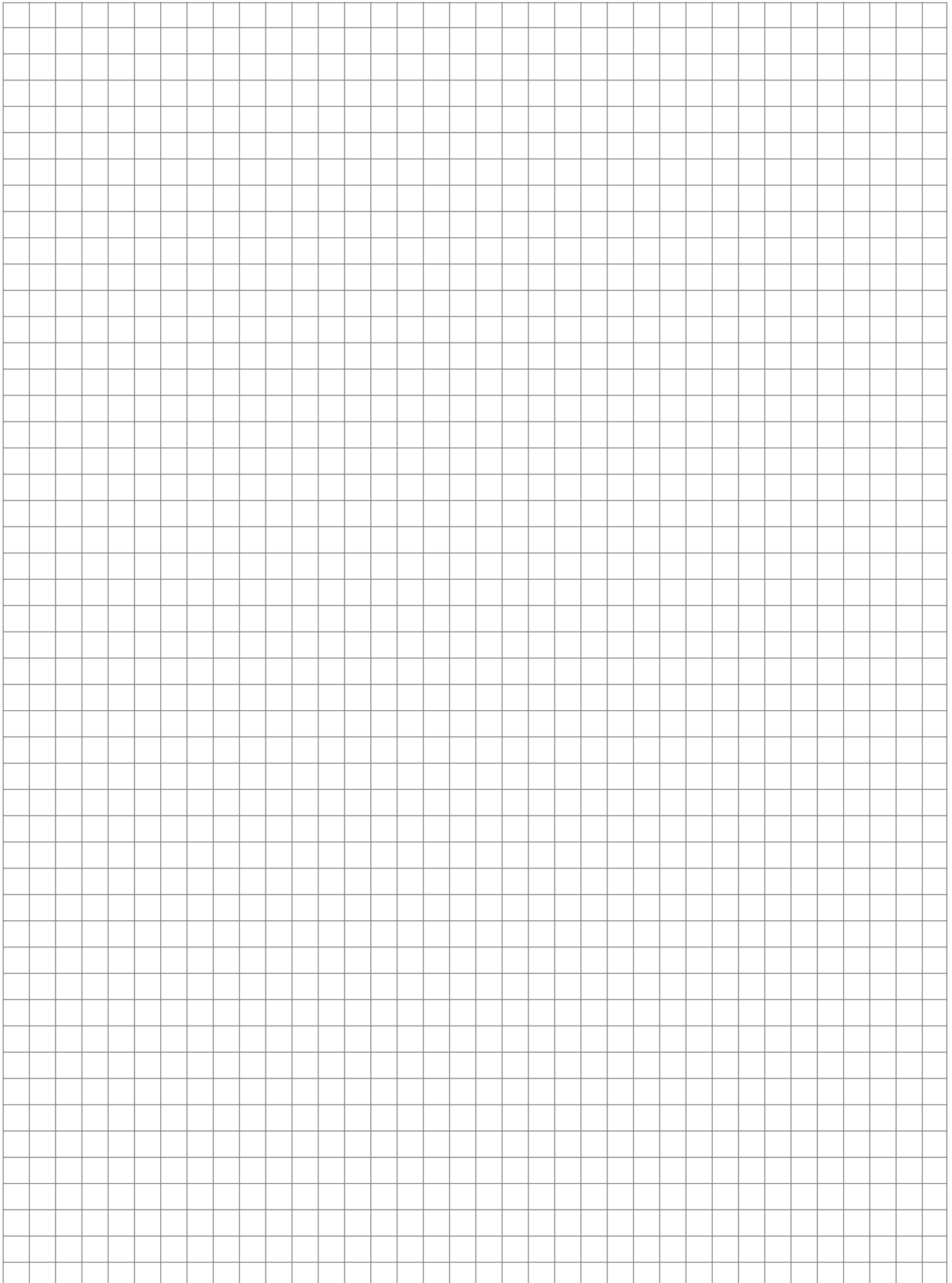

São Carlos School of Engineering - University of São Paulo
Admission Exam PPG-EM – 2022/2º sem

Name: _____ Signature: _____

QUESTION 7: (General Mechanics)

A homogeneous disk of radius r and mass m is mounted on an axis OG of length L and negligible mass. The axle is pivoted at a fixed point O , and the disk is forced to roll on a horizontal floor. Knowing that the disk rotates counterclockwise with constant angular velocity ω_1 with respect to the axis, determine (a) the force exerted by the floor on the disk and (b) the reaction at joint O .

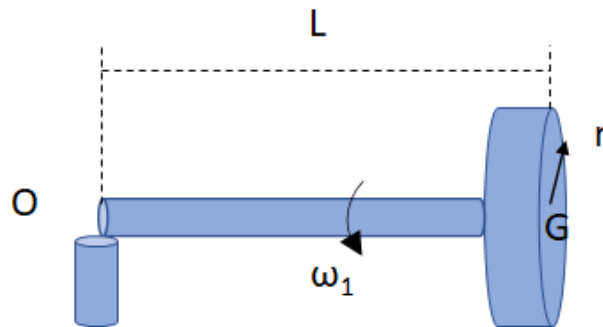

Justify your answer in the checkered area.

Answer:

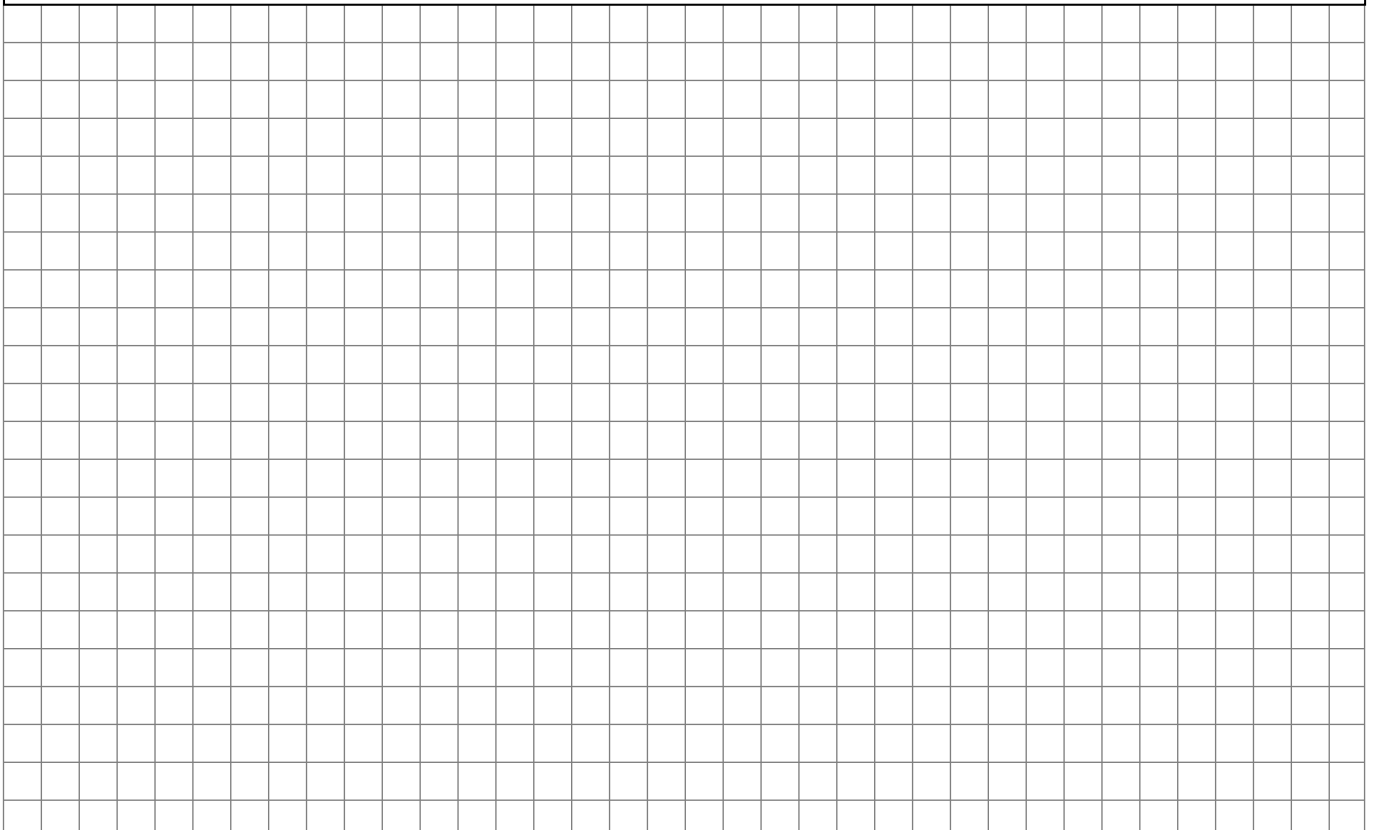

São Carlos School of Engineering - University of São Paulo
Admission Exam PPG-EM - 2022/2º sem

Name: _____ Signature: _____

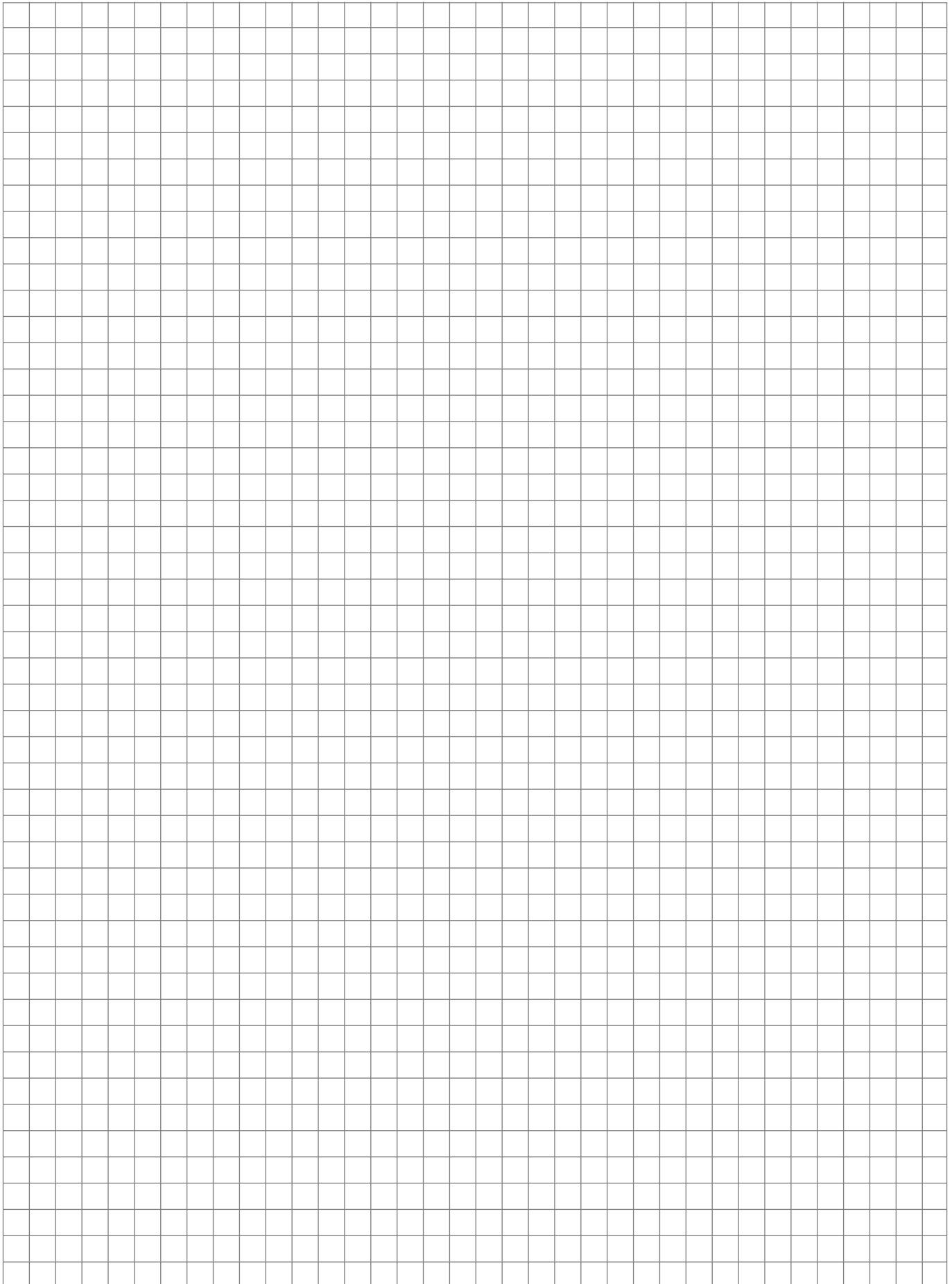

Name: _____ Signature: _____

QUESTION 8: (Solid Mechanics)

A round metallic tube was reformed to the cross section in the square shape as shown in the sectional figure below.

(a) Determine the relationships between average shears stress and angles of twist between circular tubes versus square tubes when a torque (T) is applied to the ends of the tube.

(b) Which section profile is more resistant to shear and which is more rigid to torsion?

Note: Neglect the effect of stress concentrations at the corners of the square tube.

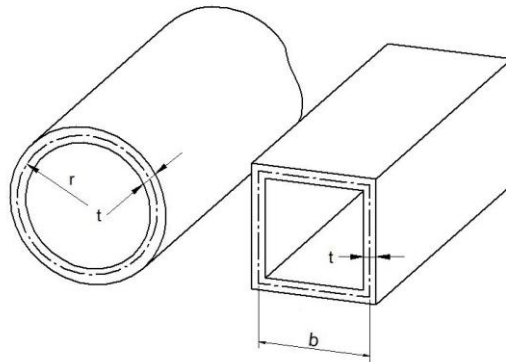

Complementary information: $\tau_{med} = \frac{T}{2tA_m}$ $\theta = \frac{\tau_{med}}{A_m}$

A_m = average area (inside the dashed line)

Justify your answer in the checkered area.

Answer:

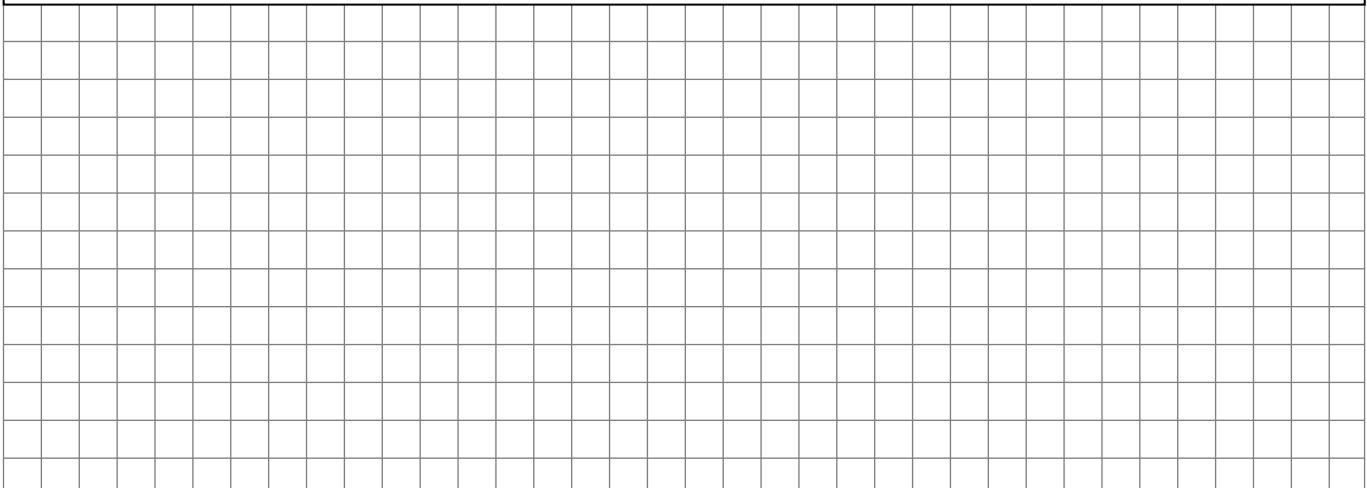

São Carlos School of Engineering - University of São Paulo
Admission Exam PPG-EM - 2022/2º sem

Name: _____ Signature: _____

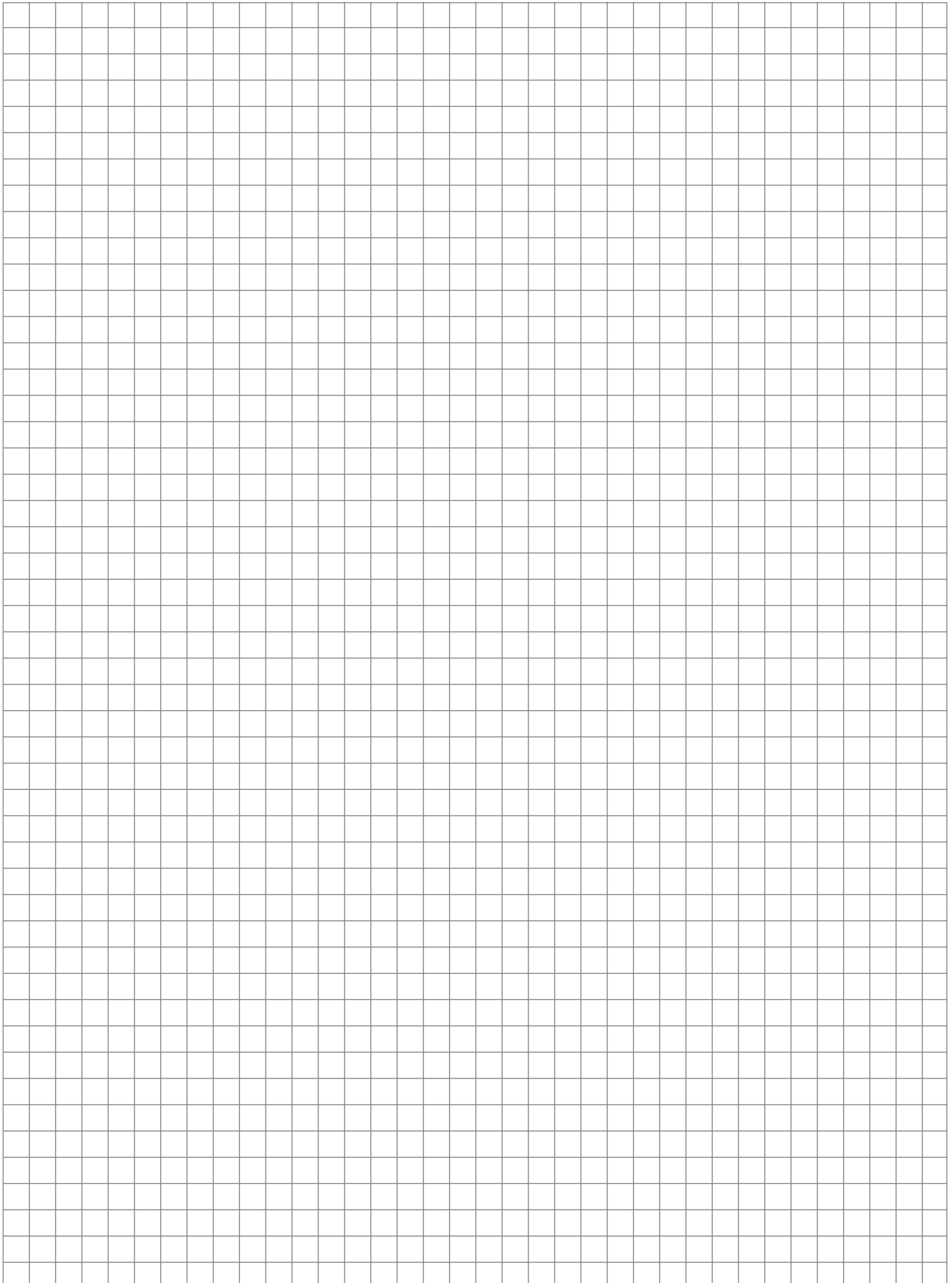

Name: _____ Signature: _____

QUESTION 9: (Thermodynamics)

The cylinder-piston arrangement of figure below contains 1 kg of air at atmospheric pressure (100 kPa) and a temperature of 300 K at state 1. In this state the tank on the piston is initially empty. From this initial condition, the tank slowly fills with water until it contains 50 kg of water and the air reaches state 2. As the process is carried out very slowly, the air temperature remains constant (300 K) due to heat transfer from the air to the outside. Assuming that the air behaves as an ideal gas ($R = 287.0 \text{ J}/(\text{kg}\cdot\text{K})$) and that the piston has negligible mass, determine:

- (a) The volume that the air occupies in state 2.
 (b) The work done on the air.

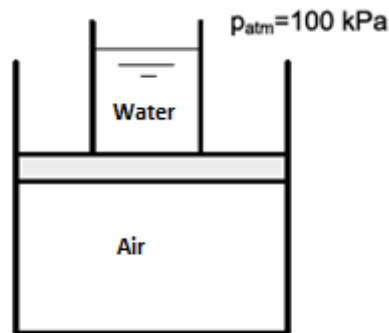

Assume that the isothermal compression process of air is modeled by $P\forall = \text{CTE}$. The piston area is equal to 0.04 m^2 and the gravitational acceleration to $g = 10 \text{ m/s}^2$. The atmospheric pressure, P_{atm} , is constant and equal to 100 kPa.

Relationships: ${}_1W_2 = \int_1^2 P d\forall \text{ [J]}; \quad {}_1Q_2 = \Delta E = E_2 - E_1 + {}_1W_2 \text{ [J]}; \quad P\forall = mRT$

Where: W – Work [J]; E – Total energy [J]; Q – Heat [J]; \forall – Volume [m^3]; P – Thermodynamic pressure [Pa]; and CTE – Constant.

Justify your answer in the checkered area.

Answer:

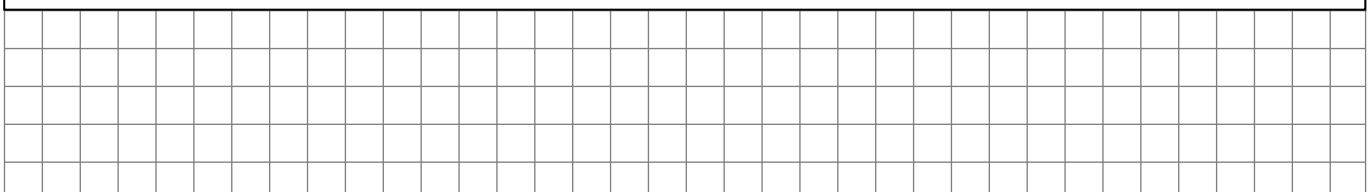

São Carlos School of Engineering - University of São Paulo
Admission Exam PPG-EM - 2022/2º sem

Name: _____ Signature: _____

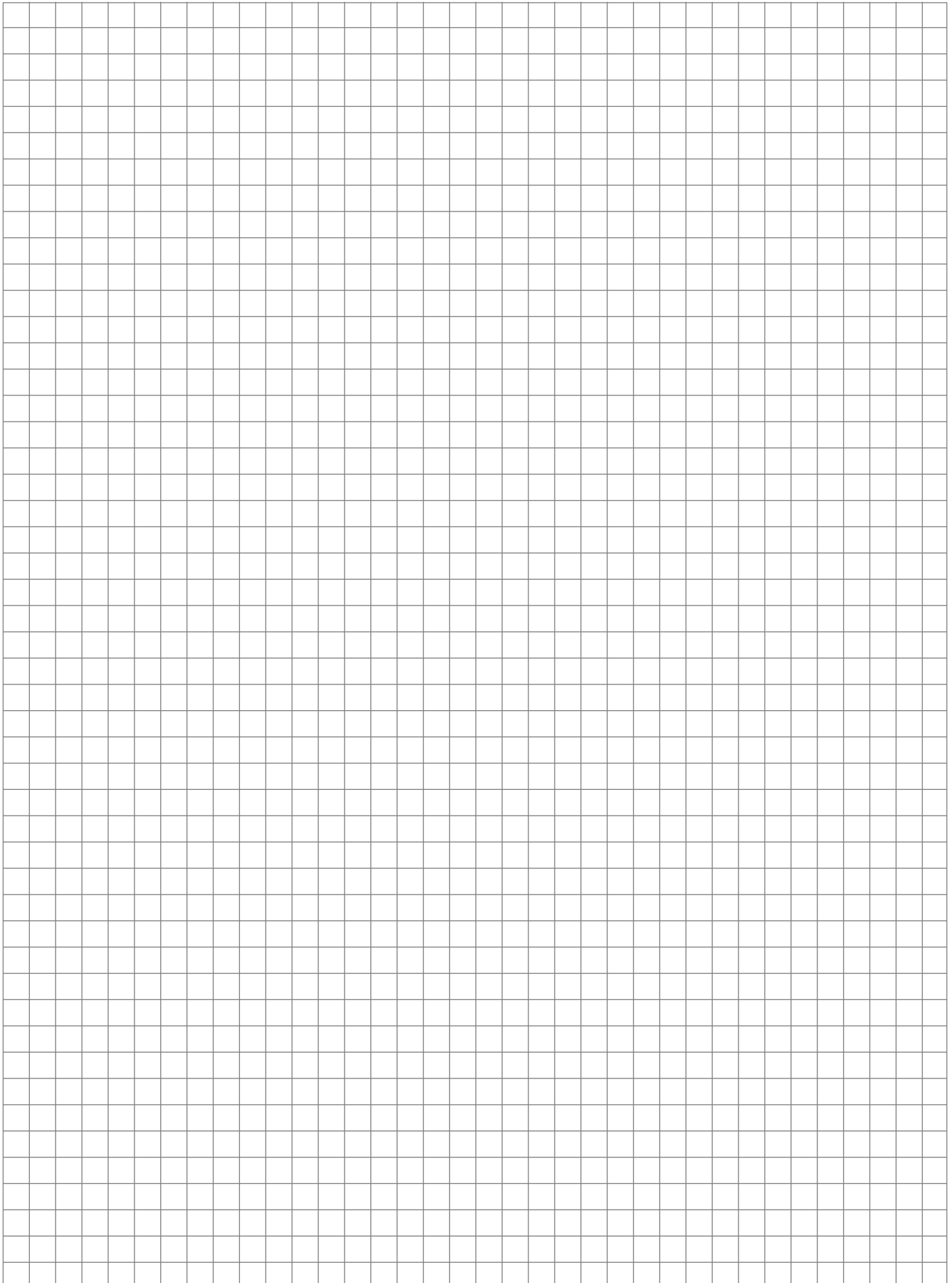

Name: _____ Signature: _____

QUESTION 10: (Fluid Mechanics)

Calculate the velocity profile of the steady, incompressible two-dimensional laminar flow between two infinite parallel flat plates, under a pressure gradient. The lower plate moves with velocity U , while the upper plate is stationary, as shown in the figure.



Relationships:

$$\frac{\partial u}{\partial x} + \frac{\partial v}{\partial y} = 0$$

$$\frac{\partial u}{\partial t} + u \frac{\partial u}{\partial x} + v \frac{\partial u}{\partial y} = -\frac{1}{\rho} \frac{\partial p}{\partial x} + \nu \left(\frac{\partial^2 u}{\partial x^2} + \frac{\partial^2 u}{\partial y^2} \right) + g_x$$

$$\frac{\partial v}{\partial t} + u \frac{\partial v}{\partial x} + v \frac{\partial v}{\partial y} = -\frac{1}{\rho} \frac{\partial p}{\partial y} + \nu \left(\frac{\partial^2 v}{\partial x^2} + \frac{\partial^2 v}{\partial y^2} \right) + g_y$$

Justify your answer in the checkered area.

Answer:

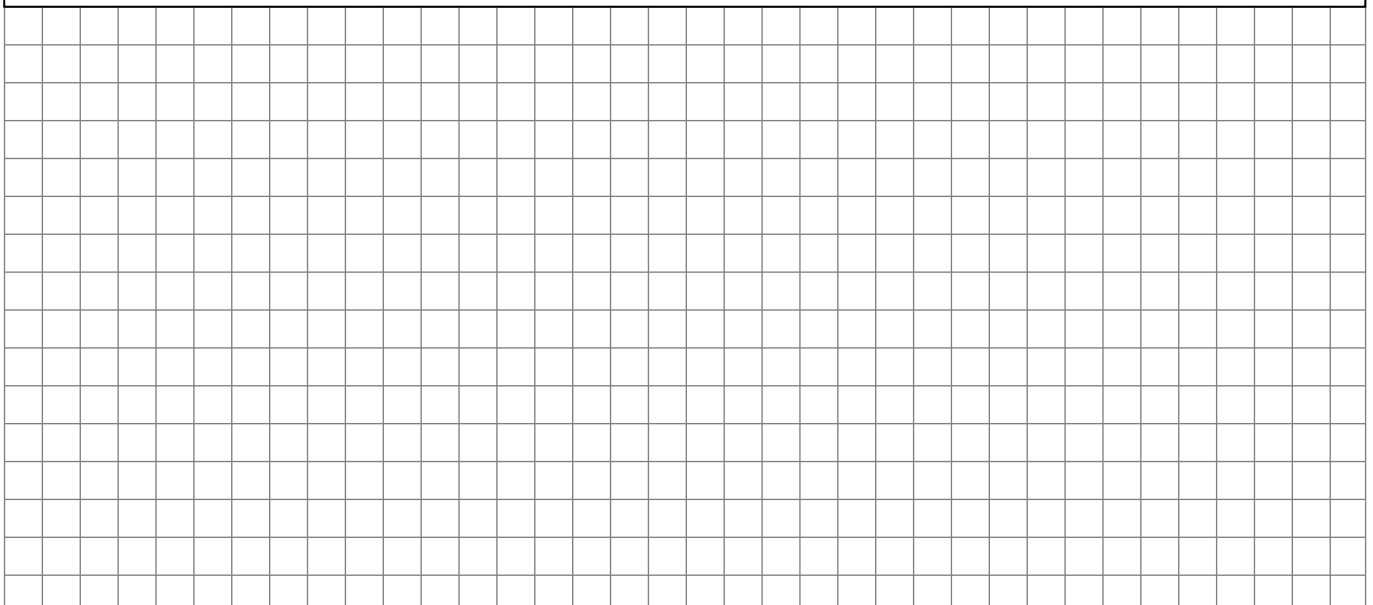

São Carlos School of Engineering - University of São Paulo
Admission Exam PPG-EM - 2022/2º sem

Name: _____ Signature: _____

